

Premium Preparation 1400 mm Work Table with Upstand - Right Bowl

ITEM # _____

MODEL # _____

NAME # _____

SIS # _____

AIA # _____

133061 (TL1410DXEN)

 Work Table with right-hand
 bowl, upstand and WorkTop,
 1400mm

Short Form Specification

Item No. _____

The 50mm high worktop in 304 AISI stainless steel, 1,5mm in thickness, is sound-deadened and has anti-drip edges and welded corners. Under-top reinforcement in 304 AISI stainless steel. Integral rear upstand, h=100mm, with 10mm radius.

Round section legs and feet in 304 AISI stainless steel, 50mm in diameter. Height-adjustable feet (+0-50mm).

Single-pressed, sound-deadened bowl mm 400x400x200h with overflow pipe and drain hole (1"1/2). Bowl on the right hand side.

Main Features

- The table can be ordered with the drawer of 400 mm or 600 mm (optional accessory): thanks to the design of the drawer, additional drawers can be added to the first single drawer to create chest of 2, 3 or 4 drawers based on customer's needs.
- Sturdiness, stability and reliability of table accurately tested.

Construction

- 100 mm upstand with 10 mm radiused corner and 13 mm deep, designed to be used against a wall.
- Worktop with 50 mm high profile, in s/s Scotch Brite finishing, 15/10 in thickness with anti-drip edges and welded corners.
- Round section legs with feet in 304 AISI stainless steel, 50 mm in diameter, adjustable in height by +0/-40 mm.
- Delivered in knock-down package.
- Single-pressed bowl AISI 304 stainless steel bowl with overflow pipe and drain hole.
- Wide range of taps are available to suit every need.
- Upstand back completely covered with Stainless Steel welded profile.
- Heavy duty construction entirely in AISI 304 stainless steel to offer maximum durability.

Optional Accessories

- Single drawer GN 1/1, 400mm PNC 855280
- Single drawer, 600mm PNC 855281
- Lower shelf for 1400mm for units PNC 855283
- Set of 4 wheels (2 with brake) d. 100mm PNC 855288
- 3-sided underframe for 1400mm tables PNC 855291
- Additional drawer, 600mm (to set up a chest of 2, 3, 4 drawers) PNC 855295
- Additional drawer GN 1/1, 400mm (to set up a chest of 2, 3, 4 drawers) PNC 855298
- Single plastic drain syphon 1,5 " for work tables with bowl PNC 855306
- Elbow operated mixer tap with spout 3/4", single hole PNC 855322
- Elbow operated mixer tap with short spout 3/4", single hole PNC 855323
- Foot operated mixer tap (hot and cold) with spout 3/4" PNC 855328

APPROVAL: _____

Front

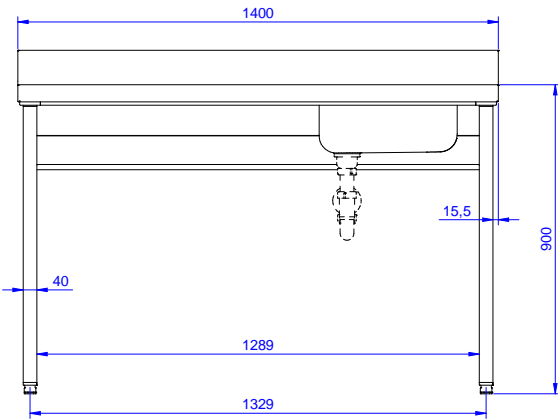

Side

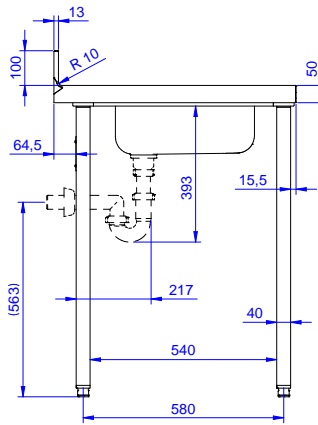

D = Drain

Top

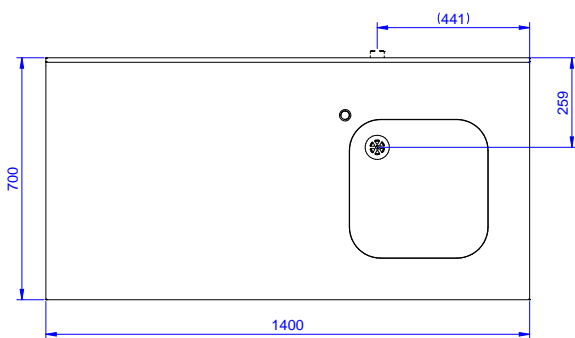



Electrolux
PROFESSIONAL

Premium Preparation 1400 mm Work Table with Upstand - Right Bowl

Key Information:

External dimensions,
Width:

133061 (TL1410DXEN) 1400 mm

External dimensions,
Depth:

700 mm

External dimensions,
Height:

900 mm

Upstand Dimensions,
Height:

100 mm

Upstand Dimensions,
Depth:

13 mm

Upstand Dimensions,
Radius:

R=10

Bowls number

1

Bowl dimensions

400x400xH250

Worktop thickness:

50 mm

Net weight:

45 kg



Premium Preparation
1400 mm Work Table with Upstand - Right Bowl

The company reserves the right to make modifications to the products
without prior notice. All information correct at time of printing.

2026.05.23